

PYLON

PUBLIC COMPANY LIMITED

Company Profile



We build foundation!!



We build foundation!!

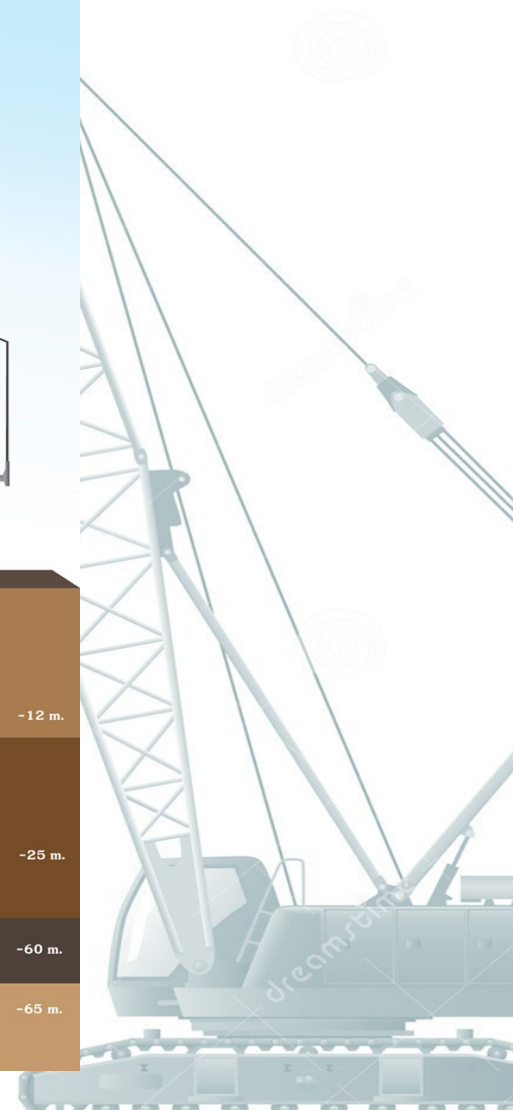

Bored Pile



- Circular bored piles for foundation of buildings, bridges, factories, roads, etc.
- \varnothing 0.5 – 2.0 m. x Depth up to 100 m.



Barrette Pile/Diaphragm Wall



- Barrettes are rectangular piles with typical width 0.8,1.0,1.2 m, length 2.8-3.0 m, and depth up to 80 m.
- D-wall is used for soil retaining system e.g. permanent wall of deep basement, underpass tunnel, subway station, etc.



Jet Grouting



- For soil improvement both stability and strength : road works, airport runway, slope protection, dam, etc.

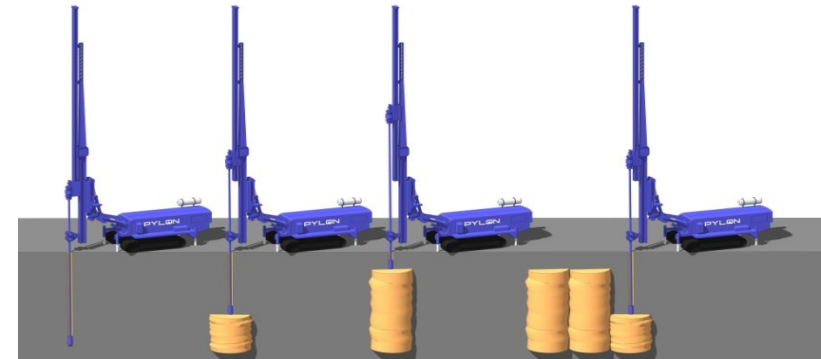

Executives



Dr. Chanet Sangarayakul

President

Age : 52

Education :

- Doctor of Engineering (structure), Asian Institute of Technology
- Master of Engineering (structure), Asian Institute of Technology
- Bachelor of Engineering (civil), Chulalongkorn University



Mr. Pisun Sirisuksakulchai

Senior Executive Vice President

Age : 52

Education :

- Master of Art in Business Law, Chulalongkorn University
- Master of Business Administration(MBA), Rockhurst University (USA)
- Master of Science (Construction Management), University of Wisconsin-Madison (USA)
- Bachelor of Engineering (civil), Chulalongkorn University



Mr. Bordin Sangarayakul

Senior Executive Vice President

Age : 51

Education :

- Master of Science (Construction Engineering and Management), Virginia Tech (USA)
- Bachelor of Engineering (civil), Chulalongkorn University



Mr. Somsak Viriyapipat

Senior Executive Vice President

Age : 67

Education :

- Bachelor of Engineering (mechanic), King Mongkut's Institute of Technology North Bangkok

Company Achievements



- We are listed in SET.
(The Stock Exchange of Thailand)

- We are selected as one of the
“Best under a Billion” by
Forbes Asia in 2014, 2019 & 2020



Company Achievements



➤ SET AWARDS:



2009 **“Top Corporate Governance Report”**

2019 **“Outstanding Company Performance”**

2019 **“Outstanding CEO”**

➤ **“Excellent CG score”**

from SET since 2016 - 2023



➤ We are certified and a member of

Thailand’s Private Sector Collective Action Coalition Against Corruption



ISO 9001:2015 Certification



Certificate TH22/00000803
The management system of
PYLON PUBLIC COMPANY LIMITED



252 SPE Tower Building, 14th floor, Phaholyothin Road, Sam Sen Nai Subdistrict, Phayathai District, Bangkok 10400, Thailand

has been assessed and certified as meeting the requirements of
ISO 9001:2015

For the following activities
Construction and Project Management of Bored Pile, Barrette Pile, and Diaphragm Wall Works

This certificate is valid from 28 October 2025 until 27 October 2028 and remains valid subject to satisfactory surveillance audits.
Issue 2. Certified since 28 October 2022

L. Moran

Authorised by
Liz Moran
Business Manager

SGS United Kingdom Ltd
Rossmore Business Park, Ellesmere Port, Cheshire, CH65 3EN, UK
t +44 (0)151 350-6666 - www.sgs.com



This document is an authentic electronic certificate for Client business purposes use only. Printed version of the electronic certificate are permitted and will be considered as a copy. This document is issued by the Company subject to SGS General Conditions of certification services available on Terms and Conditions | SGS. Attention is drawn to the limitation of liability, indemnification and jurisdictional clauses contained therein. This document is copyright protected and any unauthorized alteration, forgery or falsification of the content or appearance of this document is unlawful.



Certificate TH22/00000804
The management system of
PYLON PUBLIC COMPANY LIMITED



252 SPE Tower Building, 14th floor, Phaholyothin Road, Sam Sen Nai Subdistrict, Phayathai District, Bangkok 10400, Thailand

has been assessed and certified as meeting the requirements of
ISO 9001:2015

For the following activities
Construction and Project Management of Bored Pile, Barrette Pile, and Diaphragm Wall Works

This certificate is valid from 28 October 2025 until 27 October 2028 and remains valid subject to satisfactory surveillance audits.
Issue 2. Certified since 28 October 2022

Montree T.

Authorised by
Montree Tangtermsirikul

SGS (Thailand) Limited
238 TRR Tower, 19th-21st Floor, Naradhiwas Rajanagarindra Road, Chong Nonsi, Yannawa, Bangkok 10120 Thailand
t +66 (0)2 678 1813 - www.sgs.com



This document is an authentic electronic certificate for Client business purposes use only. Printed version of the electronic certificate are permitted and will be considered as a copy. This document is issued by the Company subject to SGS General Conditions of certification services available on Terms and Conditions | SGS. Attention is drawn to the limitation of liability, indemnification and jurisdictional clauses contained therein. This document is copyright protected and any unauthorized alteration, forgery or falsification of the content or appearance of this document is unlawful.



Company Financial Information



➤ Registered Capital = 374.94 MB

Unit : M.Baht

Period as of	Y/E 2021 01 Jan 2021 – 31 Dec 2021	Y/E 2022 01 Jan 2022 – 31 Dec 2022	Y/E 2023 01 Jan 2023 – 31 Dec 2023	Y/E 2024 01 Jan 2024 – 31 Dec 2024	Y/E 2025 01 Jan 2025 – 31 Dec 2025
Financial Data					
Assets	1,212.32	1,278.96	1,268.81	1,096.84	1,513.07
Liabilities	234.81	226.65	222.64	153.92	389.35
Equity	977.51	1,052.31	1,046.17	942.91	1,123.71
Paid-up Capital	374.94	374.94	374.94	374.94	374.94
Revenue	793.87	1,157.73	1,486.89	821.13	1,501.71
Profit (Loss) from Other Activities	1.48	2.09	3.85	6.93	3.52
Net Profit	39.76	119.79	106.34	0.50	210.79
EPS (Baht)	0.05	0.16	0.14	-	0.28
Financial Ratio					
ROA (%)	3.68	11.88	10.35	0.02	20.20
ROE (%)	3.93	11.80	10.13	0.05	20.40
Net Profit Margin (%)	5.01	10.35	7.15	0.06	14.04

Project Highlight



Queen Sirikit National Convention Center
Bored Piles / Pile walls / D-Wall

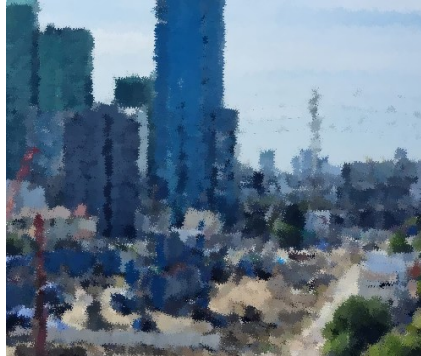

Northpole
Bored Piles / D-Wall



Hatai
Bored Piles / D-Wall



Wan Vela
Bored Piles



Cloud 11
Bored Piles / Pile walls / D-Wall



The ICONSIAM
Bored Piles / Jet Grouting



Airport Rail Link
Bored Piles



EGAT Car park & HQ
Bored Piles / Constructions



MRT Yellow & Pink Line
Bored Piles / Barrette Pile



Samyarn Mitrtown
Bored Piles / D-Wall

Project Highlight



ShowDC
Bored Piles



Central Westgate
Bored Piles



Siam Square One
Bored Piles



The One Residence
Bored Piles



AIA - CMC
Bored Piles



One9Five Rama9
Bored Piles



Klong Suvarnabhumi
Jet Grouting



TC Green I/II
Bored Piles



IKEA Westgate
Bored Piles

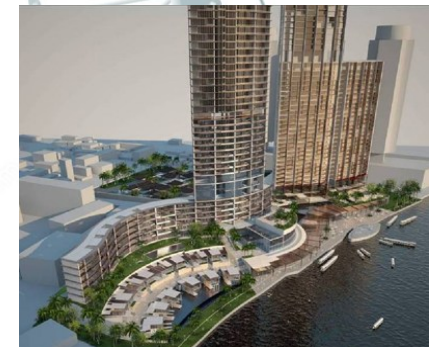

Landmark Waterfront
Bored Piles / Jet Grouting

Project Highlight



Metro Avenue
Bored Piles



South Interchange
Bored Piles



Le Luk Condo (A+B)
Bored Piles



Wimutti Hospital
Bored Piles/Barrette Piles/
D-Wall



Thai National Assembly
Bored Piles



AIA - Sathorn
Bored Piles



Amanta Condo Rama4
Bored Piles



**Suwanbabhumi
Fire Rescue Stations**
Jet Grouting



Circle Living Prototype
Bored Piles



Starview
Bored Piles

Project Highlight



AP Groups



Life Asoke-Rama9
Bored Piles



Life Asoke
Bored Piles



Aspire Erawan
Bored Piles



Life on wireless
Bored Piles

LPN Development



Lumpini Park Rama9
Bored Piles



L.P.N. Ville Nakorn In
Bored Piles



L.P.N. Beach Jomtien
Bored Piles



L.P.N. Phetkasem 98
Bored Piles

Project Highlight

Pruksa Real Estate



Plum Condo Ph.1-2
Bored Piles



Privacy Rama9
Bored Piles



Tree Interchange
Bored Piles



Chapter One
Bored Piles

Ananda Development



Buddha Port
Bored Piles



Ashton Residence 41
Bored Piles



IDEO Q Chidlom
Bored Piles



IDEO Mobi Rama 9
Bored Piles

Project Highlight



Narai Property



Parkland Charan
Bored Piles



**Parkland Ratchada-
Wongsawang**
Bored Piles



**Parkland
Phetkasem56**
Bored Piles



**Parkland
Phetkasem-Taphra**
Bored Piles

Major Development



Muniq SK23
Bored Piles



Metris Ladprao
Bored Piles



Maestro07
Bored Piles



Maestro19
Bored Piles

Ongoing Projects



MRT Orange Line Bang Khun Non - Min Buri (Suwinthawong) Section



OR11

D-Wall

1.00 m. thk. x 30 m. depth 478.62 m.

Barrette

1.00x3.0 m. depth 54 m. 25 Nos.

1.00x3.0 m. depth 56 m. 12 Nos.

IVS06

D-Wall

1.20 m. thk. x 56.05 m. depth 95.42 m.

Barrette

1.20x3.0 m. depth 69.70 m. 2 Nos.

IVS07 Construction Period: July 2026

D-Wall

1.00 m. thk. x 42.20 m. depth 130.049 m.

Barrette

1.00x3.0 m. depth 65.20 m. 5 Nos.

Ongoing Projects

The Ritz-Carlton Bangkok, The Riverside



Bored Piles

Ø 0.60 m. depth 35 m.	161 Nos
Ø 1.20 m. depth 70 m.	72 Nos
Ø 1.35 m. depth 70 m.	46 Nos

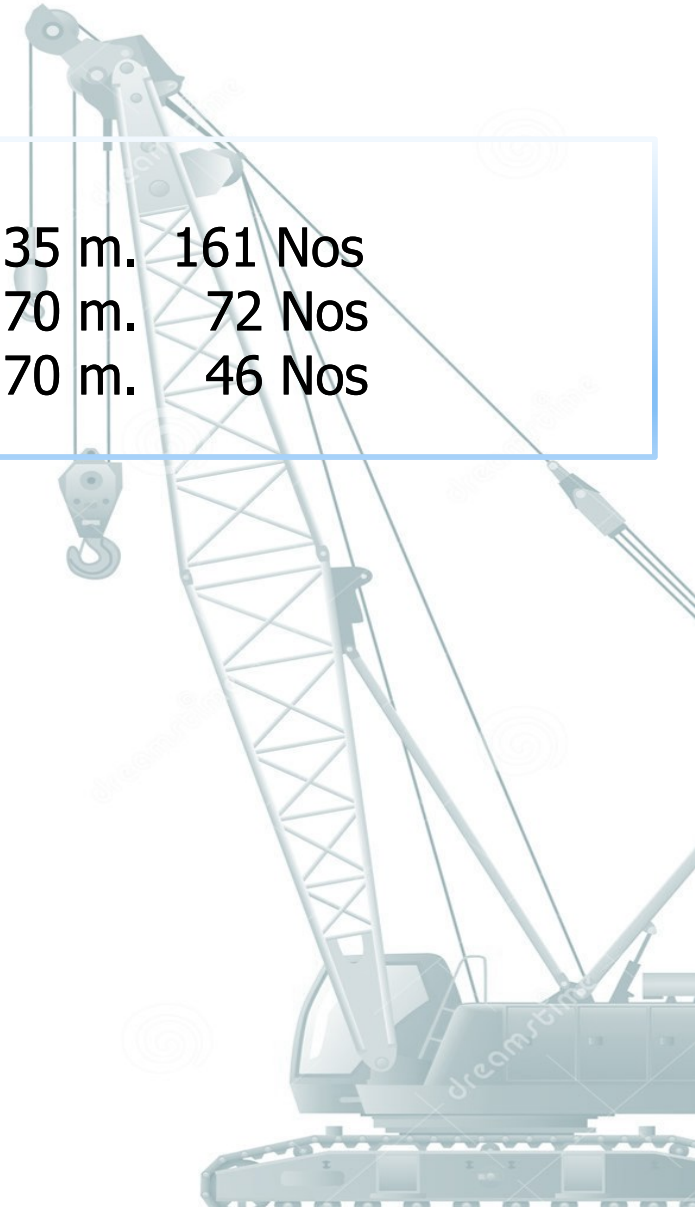

Ongoing Projects

Hercules (BDMS Wellness)



Bored Piles

- Ø 0.60 m. depth 35 m. 70 Nos
- Ø 0.80 m. depth 60 m. 59 Nos
- Ø 1.00 m. depth 60 m. 12 Nos
- Ø 1.20 m. depth 65 m. 144 Nos
- Ø 1.20 m. depth 70 m. 309 Nos
- Ø 1.35 m. depth 70 m. 88 Nos
- Ø 1.50 m. depth 70 m. 35 Nos
- Ø 1.80 m. depth 65 m. 23 Nos
- Ø 1.80 m. depth 70 m. 8 Nos
- Ø 1.20 m. depth 30 m. 183 Nos

Barrette

- 1.00x2.80 m. depth 60 m. 38 Nos

D-Wall

- 1.00 m. thk. x 32 m. depth 381.82 m.

Ongoing Projects



Moxy Bangkok Silom



Bored Piles

Ø 0.60 m. depth 32 m. 34 Nos

Ø 1.00 m. depth 63 m. 5 Nos

Ø 1.20 m. depth 63 m. 50 Nos

Pile Wall

Ø 0.80 m. depth 19 m. 164 Nos

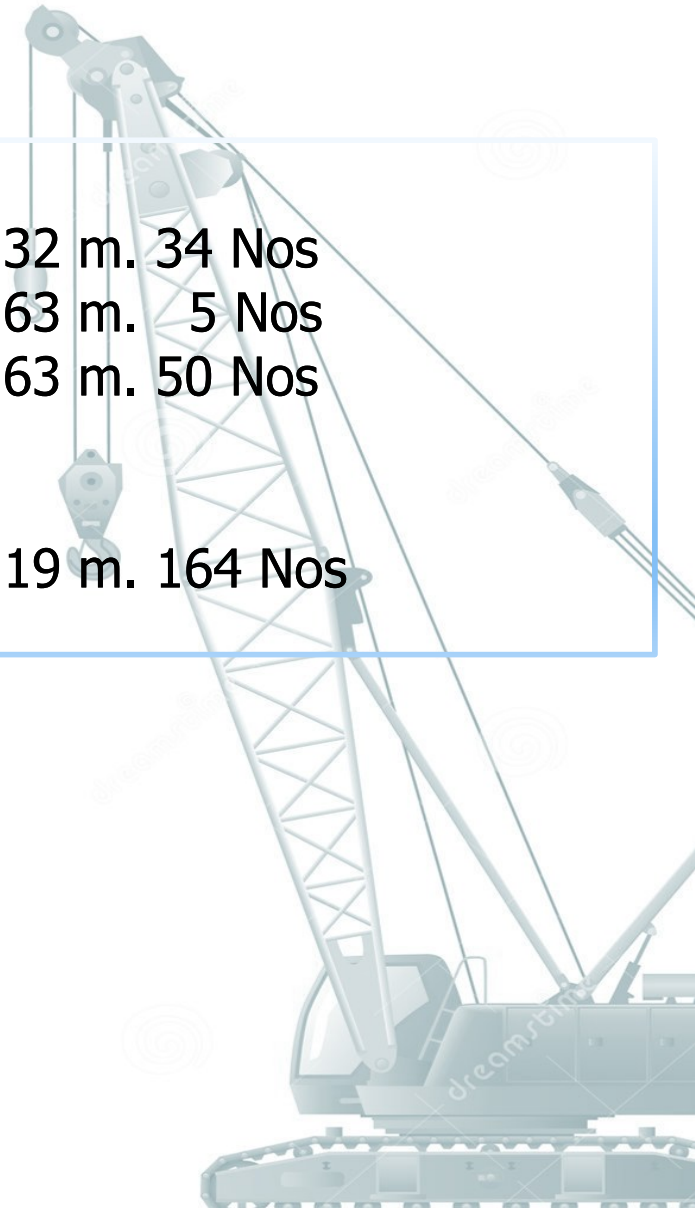

Ongoing Projects



Grande Centre Point Chinatown



Bored Piles

Ø 0.80 m. depth 50 m. 109 Nos

Ø 1.00 m. depth 50 m. 105 Nos

Barrette

1.00x3.00 m. depth 50 m. 22 Nos

D-Wall

1.00 m. thk. x 23 m. depth 240 m.

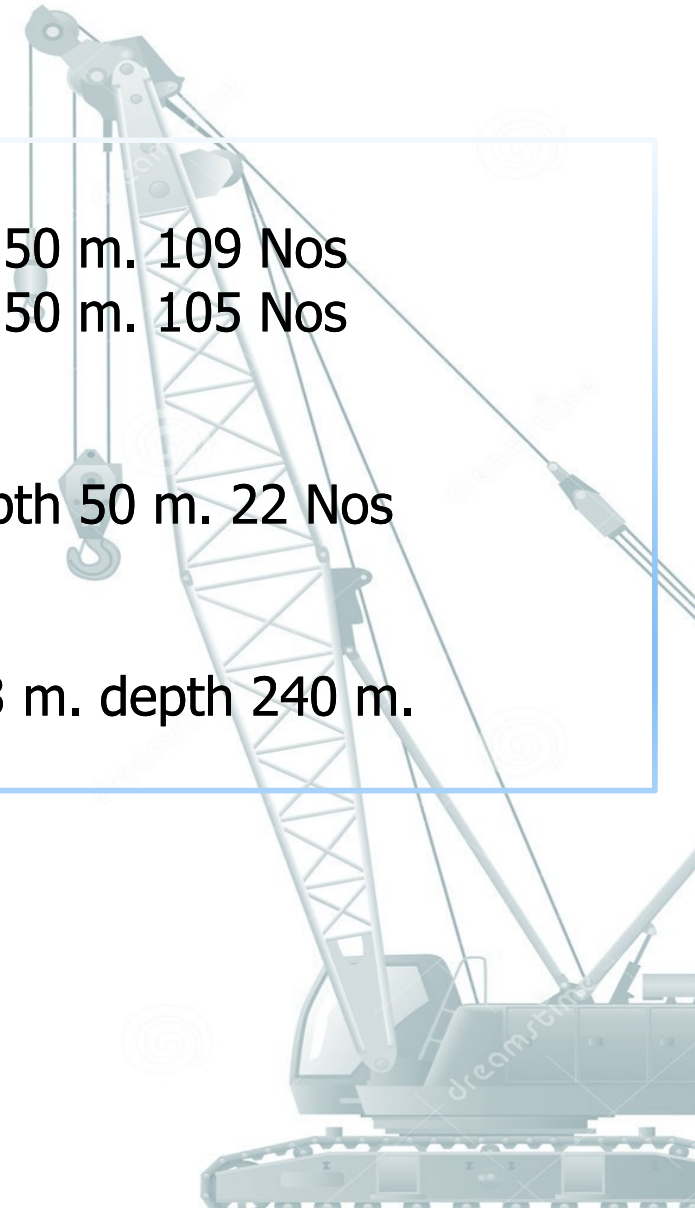

Ongoing Projects



Life JJ Interchange & Life JJ Interchange Pet Pal



Bored Piles

Ø 0.60 m. depth 38 m. 179 Nos

Ø 0.80 m. depth 38 m. 108 Nos

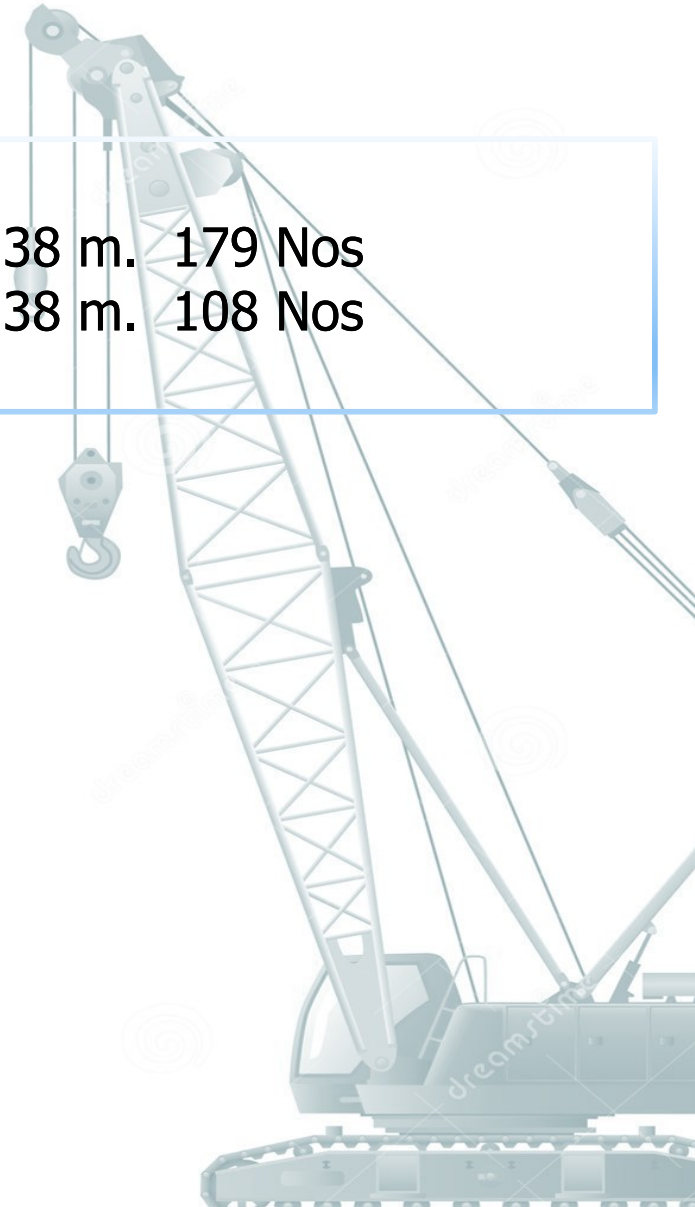

Ongoing Projects

Ratchadamri Project



Bored Piles

Ø 1.00 m. depth 19 m. 88 Nos
Ø 1.20 m. depth 21 m. 258 Nos
Ø 1.20 m. depth 65 m. 85 Nos
Ø 1.50 m. depth 88 m. 117 Nos

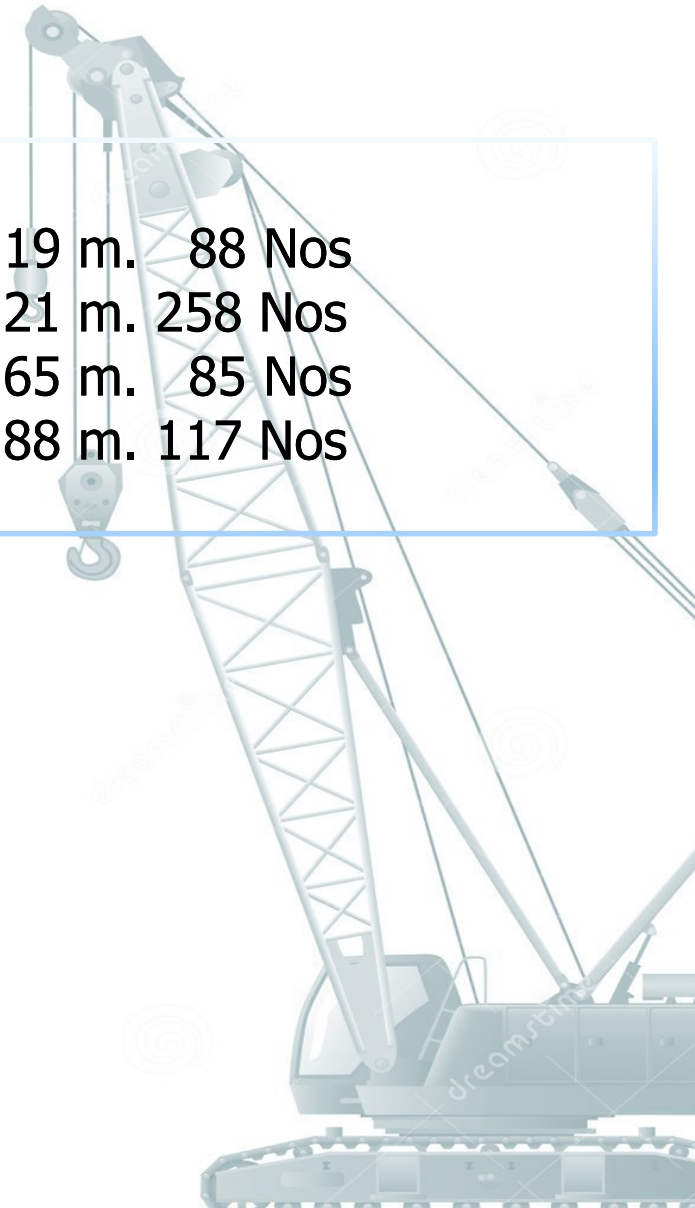

Upcoming Projects



Proton Therapy



Construction Period: April 2026

Pile Wall

Ø 0.60 m. depth 16.60 m. 278 Nos

Bored Piles

Ø 1.00 m. depth 60 m. 48 Nos

Ø 1.20 m. depth 60 m. 84 Nos

Upcoming Projects



Central Embassy 2.2



Construction Period: April 2026

Bored Piles

Ø 1.50 m. depth 69 m. 47 Nos
Ø 1.80 m. depth 63 - 93 m. 385 Nos
Ø 2.00 m. depth 70 - 98 m. 82 Nos

Barrette

1.00x3.00 m. depth 57 m. 45 Nos
1.00x3.80 m. depth 72 m. 25 Nos

D-Wall

0.80 m. thk. x 33 m. depth 5.45 m.
1.00 m. thk. x 29 - 36 m. depth 714.47 m.

Upcoming Projects



AIP TWO



Construction Period: May 2026

Bored Piles

Ø 1.00 m. depth 60 m. 70 Nos

Ø 1.20 m. depth 60 m. 44 Nos

D-Wall

0.80 m. thk. x 22 m. depth 130.68 m.

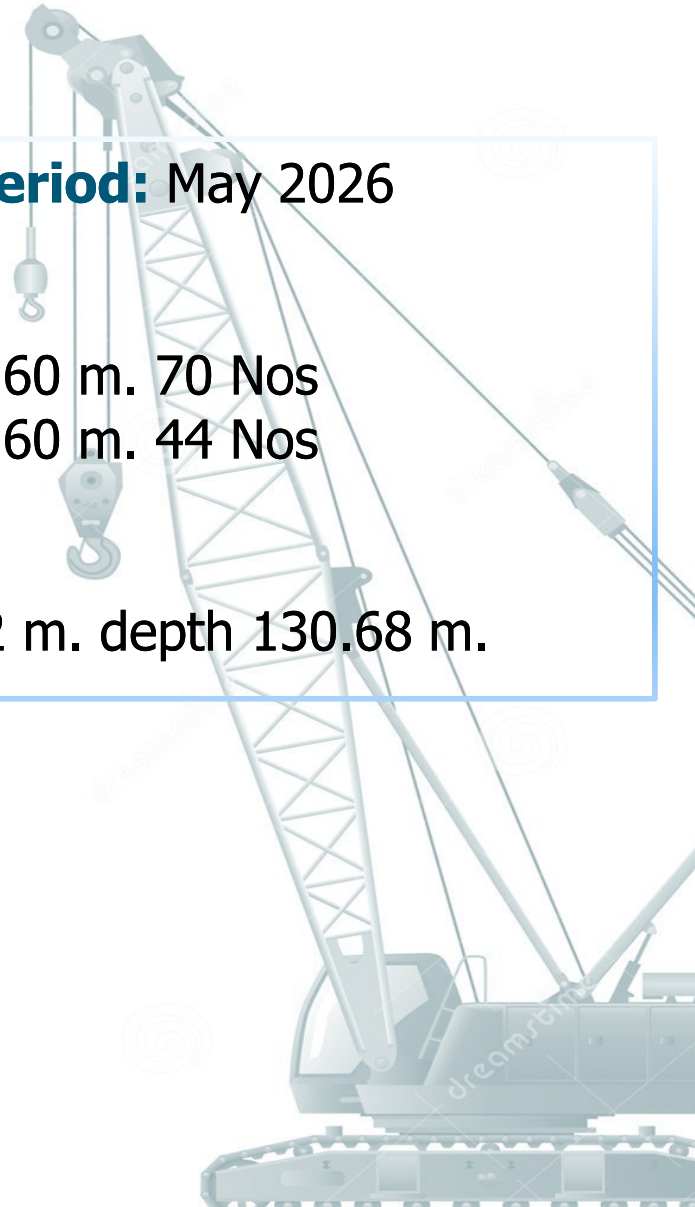

Project Highlight



Woeng Nakorn Khasem



Bored Piles

Ø 1.80 m. depth 64 m. 176 Nos

Ø 2.00 m. depth 64 m. 67 Nos

D-Wall

0.80 m. thk. x 46 m. depth 205 m.

1.00 m. thk. x 31 m. depth 458.53 m.

1.00 m. thk. x 46 m. depth 12 m.

Barrette

1.00x3.0 m. depth 64 m. 76 Nos

Project Highlight



Narai Hotel



Construction Period: 18/06/24 – 13/01/25

Bored Piles

Ø 0.60 m. depth 16 m. 80 Nos
Ø 1.00 m. depth 65 m. 104 Nos
Ø 1.20 m. depth 65 m. 64 Nos
Ø 1.50 m. depth 65 m. 117 Nos

D-Wall

0.80 m. thk. x 40 m. depth 186.15 m.
1.00 m. thk. x 40 m. depth. 209.10 m.

Stanchion Pile

H350x350 104 Nos

Project Highlight



Embassy Wireless



Construction Period: 18/06/24 - 20/10/24

Bored Piles

- Ø 1.00 m. depth 65 m. 14 Nos
- Ø 1.20 m. depth 65 m. 128 Nos
- Ø 1.20 m. depth 70 m. 33 Nos
- Ø 1.50 m. depth 65 m. 2 Nos

D-Wall

0.80 m.thk. x 23 m. depth 200.65 m.

Barrette

Ø 0.80x2.50 m. depth 65 m. 15 Nos

Project Highlight



Queen Sirikit National Convention Center



Construction Period: 03/10/19 - 26/02/20

Bored Piles

Ø 1.00 m. depth 64 m. 263 Nos
Ø 1.20 m. depth 64 m. 285 Nos
Ø 1.50 m. depth 64 m. 387 Nos

Pile Wall

Ø 1.20 m. depth 28 m. 248 Nos
Ø 1.20 m. depth 30 m. 117 Nos

D-Wall

1.00 m. thk. x 30 m. depth 928.52 m.

Pile Leg

Ø 1.00 m. depth 64 m. 78 Nos

Project Highlight



Cloud 11



Construction Period: 9/02/22 - 27/08/22

Bored Piles

Ø 1.20 m. Depth 70 m. 45 Nos
Ø 1.50 m. Depth 70 m. 738 Nos

Pile Wall

Ø 0.80 m. Depth 18 m. 58 Nos
Ø 0.80 m. Depth 20 m. 33 Nos
Ø 0.60 m. Depth 18 m. 983 Nos
Ø 1.00 m. Depth 20 m. 123 Nos

D-Wall

0.80 m. thk. x 23 m. depth 717.19 m.
0.80 m. thk. x 30 m. depth 503.07 m.

Project Highlight



North Pole



Construction Period: 19/12/22 - 18/11/23

Bored Piles

Ø 0.60 m. depth 22 m. 64 Nos

Ø 1.20 m. depth 45 m. 92 Nos

Ø 1.50 m. depth 70 m. 186 Nos

Ø 1.80 m. depth 70 m. 285 Nos

D-Wall

0.80 m. thk. x 22 m. depth 259.56 m.

1.00 m. thk. x 22 m. depth 182.67 m.

1.20 m. thk. x 22 m. depth 155.43 m.

1.00 m. thk. x 70 m. depth 33.00 m.

Efficiency & Quality : Pylon Pile Application



To increase **efficiency and quality**



- Collect data**
- Data centralization
 - Paperless
 - Real-time key in
 - Reporting

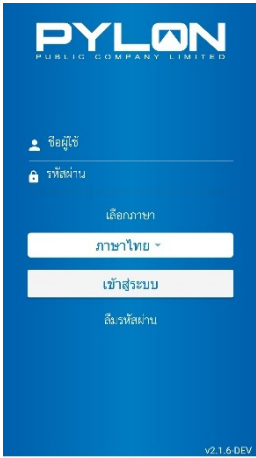

- Process and Quality Control**
- Standardization
 - Identify the key check-points
 - Approval process

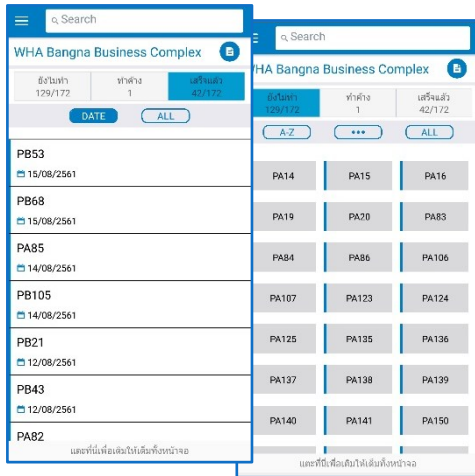
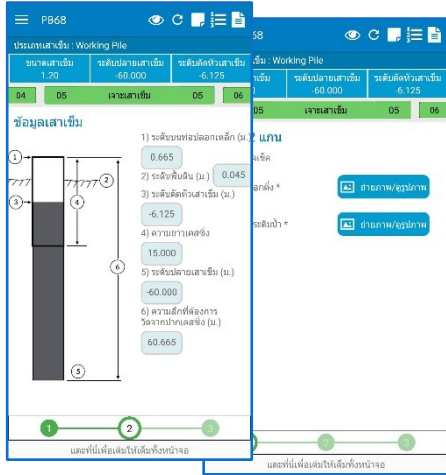

- Productivity and Budget Control**
- Work progress
 - Material control
 - Machine utilization

- Problem solving**
- Real-time detection of problems
 - Troubleshooting promptly
 - Real-time tracking

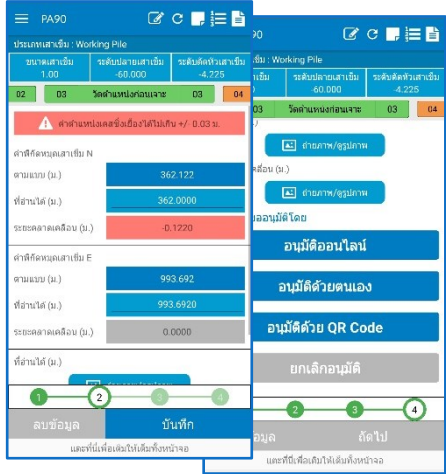

Efficiency & Quality : Pylon Pile Application

